



**artanova**  
Switzerland

**horst**  
Collection



### Herzlich willkommen bei der Horst AG

Als mein Grossvater im Jahr 1930 im Herzen der Schweiz den Grundstein für die heutige Horst AG legte, hat niemand mit der Entwicklung während der folgenden Jahrzehnte rechnen können. Heute sind in Steinen zwei Kollektionen – die Horst Collection und Artanova Switzerland – beheimatet, die die gesamte Bandbreite exklusiver Polstermöbel abdecken. Vom Klassiker bis zum Designobjekt, immer in hervorragender Qualität. Unsere Philosophie: Wir entwickeln Vielfalt ohne Kompromisse, wir designen hochwertige Möbel für jeden Geschmack.

Es ist uns eine ganz besondere Freude, Ihnen mit dieser Broschüre unsere aktuellen Kollektionen vorstellen zu dürfen. Sie ist das Resultat einer äusserst dynamischen Entwicklung während der letzten Jahre. Seit die dritte Familiengeneration 2009 die Geschäftsführung übernommen hat, weht bei der Horst AG ein frischer Wind. Unsere unternehmerischen Wurzeln und den hohen Anspruch an unsere Möbel haben wir dabei nie aus den Augen verloren.

Das Sortiment reicht heute von klassisch bis modern. Die Anzahl der Modelle haben wir kontinuierlich erweitert. Die grosse Auswahl an aktuellen Stoff- und Mikrofaserbezügen in diversen Farben und Qualitäten sowie Leder in über 100 Farben und verschiedenen Qualitäten lässt keine Wünsche offen. Kurz gesagt: Sie können aus dem Vollen schöpfen. Und das in der Schweiz und im europäischen Ausland. Nehmen Sie sich ein wenig Zeit. Blättern Sie, stöbern Sie, träumen Sie von Ihrem neuen Lieblingsplatz. Dabei wünsche ich Ihnen viel Vergnügen.

Stéphanie Horst, CEO Horst AG

### Welcome to the Horst AG

When my grandfather laid the foundation for today's Horst AG in the heart of Switzerland in 1930, no one could have expected the development over the following decades. Today, two collections – the Horst Collection and Artanova Switzerland – located in Steinen, cover the entire spectrum of exclusive upholstered furniture. From the classic to the design object, and always in outstanding quality. Our philosophy: We develop diversity without compromise, we design high-quality furniture for every taste.

It is a great pleasure for us to introduce you to our current collections with this brochure. It is the result of an extremely dynamic development during recent years. Since the third generation of the family took over the management in 2009, a fresh wind blows at Horst AG. We have never lost sight of our entrepreneurial roots and the high demand of our furniture.

Today the product assortment ranges from classic to modern. We have continuously expanded the number of models. The large selection of current fabric and microfiber covers in various colors and qualities, as well as leather in over 100 colors and various qualities, leaves nothing to be desired. In short, you can make the most of everything, in Switzerland and in other European countries. Take a little time. Scroll, browse, and dream about your new favorite place. I hope you enjoy.

Stéphanie Horst, CEO Horst AG

## Inhaltsverzeichnis . table of content

---

	achilles cover	70		grimsel	52
	amphora	66		leo	80
	apollon	10		malans	42
	avegno	60		malix	48
	bivio	12		melide	76
	castell	32		pilatus   pizol	40
	castell II	36		praden	64
	delia	20		saas-fee	24
	delphi	82		sir	65
	dyo	4		spiez	72
	elan	58		visp	84
	elegance	28		xenia	44
	evita	56		zelos	16











dyo 9192

Masse . Dimensions

Seitenansicht . Side View	Standard: Fuss Alu poliert Standard: Foot aluminium polished	Fusstütze . Footrest Höhe Tiefe . Height Depth 43 43 cm	
Plätze . Seats Sitzhöhe -tiefe . Seat Height Depth	1 46 56 cm		
Plätze . Seats Sitzhöhe -tiefe . Seat Height Depth	2,5 46 56 cm		
Plätze . Seats Sitzhöhe -tiefe . Seat Height Depth	3 46 56 cm		
Eckelement . Cornerelement Sitzhöhe -tiefe . Seat Height Depth	46 56 cm		
Liege . Couch Sitzhöhe -tiefe . Seat Height Depth	46 134 cm		





Verbindungs-Hocker . Connecting Stool

Sitzhöhe | -tiefe . Seat Height | Depth 46 | 56 cm

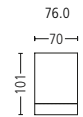

Anbau-Hocker l/r . Add-on Stool l/r

Sitzhöhe | -tiefe . Seat Height | Depth 46 | 56 cm

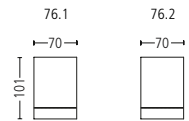

Verbindungs-Tisch . Connecting Table

Höhe . Height 35 cm

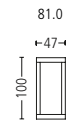

Anbau-Tisch . Add-on table

Höhe . Height 35 cm

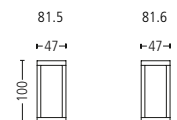

Armteil l/r . Armrest l/r

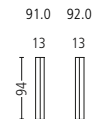

Hocker . Stool

Sitzhöhe . Seat Height 42 cm

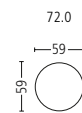

Hocker gesteppt  
Stool quilted

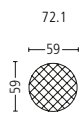

Zierkissen . Decorative Cushion

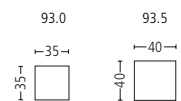

Fuss-Variation . Base variation

Fuss Alu gebürstet matt . Foot aluminium brushed matt

V 982

Fuss Alu schwarz . Foot aluminium black

V 987

apollon



# apollo 9194

Masse . Dimensions

Seitenansicht . Side View

Standard: 5-Sternfuss Stahl schwarz  
Standard: 5-star base steel black



Relaxessel elektrisch inkl. Akku . Relax Armchair electric incl. battery  
Sitzhöhe | -tiefe . Seat Height | Depth 46 | 48 cm

ohne Armteil  
without armrest

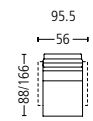

Relaxessel elektrisch inkl. Akku + Herz-Waage . Relax Armchair electric incl. battery + heart balance  
Sitzhöhe | -tiefe . Seat Height | Depth 46 | 48 cm

ohne Armteil  
without armrest

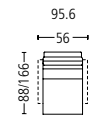

Relaxessel elektrisch inkl. Akku + Aufstehhilfe . Relax Armchair electric incl. battery + stand up assistance  
Sitzhöhe | -tiefe . Seat Height | Depth 46 | 48 cm

ohne Armteil  
without armrest

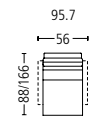

Armlehne . Armrest  
Breite . Width 7 cm

schwarz  
black



chrom glanz  
chrome shiny

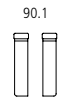

Armlehne . Armrest  
Breite . Width 9 cm

bezogen  
covered



Armlehne . Armrest  
Breite . Width 7 cm

geschlossen  
closed

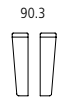

Fuss-Variation . Base variation

5-Sternfuss Stahl Chrom glanz . 5-star base steel chrome glossy

V 993





bivio 3327

Masse . Dimensions

Seitenansicht . Side View

Standard: 5-Sternfuss Alu schwarz  
Standard: 5-star base aluminium black



Relaxessel elektrisch inkl. Akku . Relax Armchair electric incl. battery  
Sitzhöhe | -tiefe . Seat Height | Depth 46 | 48 cm

ohne Armteil  
without armrest

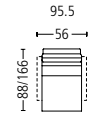

Relaxessel elektrisch inkl. Akku + Herz-Waage . Relax Armchair electric incl. battery + heart balance  
Sitzhöhe | -tiefe . Seat Height | Depth 46 | 48 cm



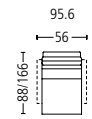

ohne Armteil  
without armrest

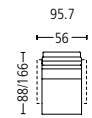

Relaxessel elektrisch inkl. Akku + Aufstehhilfe . Relax Armchair electric incl. battery + stand up assistance  
Sitzhöhe | -tiefe . Seat Height | Depth 46 | 48 cm

ohne Armteil  
without armrest



Armlehne . Armrest Breite . Width	7 cm	schwarz black	90.5 	chrom glanz chrome shiny	90.1 
Armlehne . Armrest Breite . Width	9 cm			bezogen covered	90.2 
Armlehne . Armrest Breite . Width	7 cm			geschlossen closed	90.3 
Fuss-Variation . Base variation			5-Sternfuss Alu poliert . 5-star base aluminium polished		V 994
			5-Sternfuss Stahl schwarz . 5-star base steel black		V 996
			5-Sternfuss Stahl Chrom glanz . 5-star base steel chrome glossy		V 993











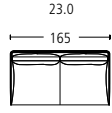
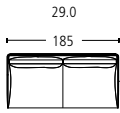
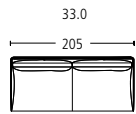





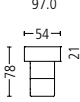

Seitenansicht . Side View	Standard: Fuss Holz Nussbaum Standard: Foot walnut wood	
Plätze . Seats Sitzhöhe   -tiefe . Seat Height   Depth	2 45   54 cm	
Plätze . Seats Sitzhöhe   -tiefe . Seat Height   Depth	2,5 45   54 cm	
Plätze . Seats Sitzhöhe   -tiefe . Seat Height   Depth	3 45   54 cm	
Cocktailsessel . Cocktail chair Sitzhöhe   -tiefe . Seat Height   Depth	43   51 cm	   <p>Tellerfuss Chrom glanz Round Base Chrome shiny</p>
Kissen . Cushion	   <p>Zierkissen Decorative Cushion</p> <p>Zierkissen mit Keder Decorative Cushion with Piping</p> <p>Zierrolle mit Keder Decorative Roll with Piping</p>	
Kopfstütze . Headrest		  
Fuss-Variation . Base variation	Fuss Alu poliert . foot aluminium polished Fuss Alu schwarz . foot aluminium black	V 983 V 996



delia





delia 9199

Masse . Dimensions

Seitenansicht . Side View

Standard: Fuss Stahl Chrom glanz  
Standard: Foot steel chrome glossy



Plätze . Seats 2,5  
Sitzhöhe | -tiefe . Seat Height | Depth 47 | 52 cm

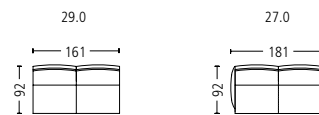

Plätze . Seats 3  
Sitzhöhe | -tiefe . Seat Height | Depth 47 | 52 cm

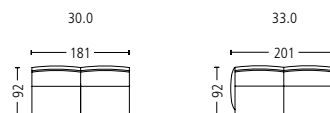

Segment . Segment 60 °  
Sitzhöhe | -tiefe . Seat Height | Depth 47 | 52 cm

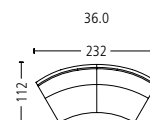

Liege l/r . Couch l/r  
Sitzhöhe | Liegetiefe  
Seat Height | Couch Depth 47 | 127 cm



Armlehne l/r . Armrest l/r  
Breite . Width 10 cm

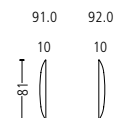

Nackensstütze verstellbar  
Adjustable neck support

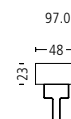



Block 237  
 Elemente . Elements 91.0 | 60.0 | 36.0 | 92.0

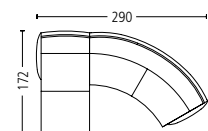

Kombination . Combination  
 Sitzhöhe | -tiefe . Seat Height | Depth 47 | 52 cm

Aussentasche . Side bag

links . left 99.1  
 rechts . right 99.2

Fuss-Variation . Base variation

Fuss Stahl schwarz . Foot steel black V 987









Produktvideo saas-fee / zermatt: Beschreibung der mechanischen Funktion.  
Product video saas-fee / zermatt: Description of the mechanical function.

## saas-fee 3318

Masse . Dimensions

Seitenansicht . Side View

Standard: Fuss schwarz, pulverbeschichtet  
Standard: Foot black, powder-coated

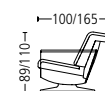

### Sofa mit elektrischer Verstellung . Sofa with electrical adjustment

Sessel . Chair 1  
Sitzhöhe | -tiefe . Seat Height | Depth 46 | 50–54 cm



Plätze . Seats 2 | 2,5  
Sitzhöhe | -tiefe . Seat Height | Depth 46 | 50–54 cm

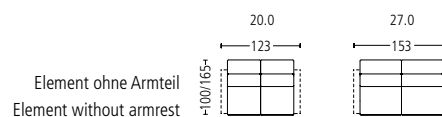

Armlehne bodenfrei . Armrest floor free  
Breite . Width 12 cm

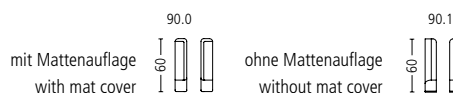

Armlehne bodennah . Armrest floor near  
Breite . Width 12 cm

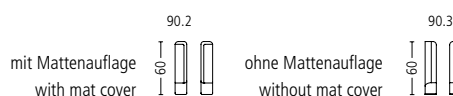

Wählbare Sitztiefe . Seat depth options

52 cm: V 800 / Standard 50 cm: V 801 / 54 cm: V 802

Fuss-Variation \* . Base variation \*

Fuss Alu 40 mm verstellbar . Foot aluminium 40 mm adjustable V 991

\* Fuss-Variation nur bei Armlehne bodennah | \* Base variation only with armrest floor near



**Sofa fix, manuell verstellbare Kopfstütze . Sofa fixed, headrest manually adjustable**

Plätze . Seats 2 | 2,5  
 Sitzhöhe | -tiefe . Seat Height | Depth 46 | 50 cm

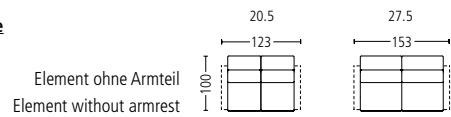

Liege . Couch 2 | 2,5  
 Sitzhöhe | -tiefe . Seat Height | Depth 46 | 50 cm

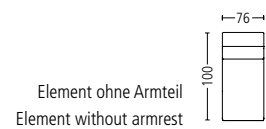

Armlehne bodenfrei . Armrest floor free  
 Breite . Width 12 cm

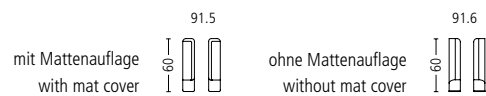

Armlehne bodennah . Armrest floor near  
 Breite . Width 12 cm

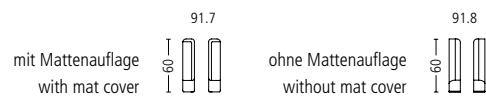

elegance





elegance



# elegance 3399

Masse . Dimensions

Seitenansicht . Side View

Standard: 5-Sternfuss Alu schwarz  
Standard: 5-star base aluminium black



Relaxsessel elektrisch inkl. Akku . Relax Armchair electric incl. battery  
Sitzhöhe | -tiefe . Seat Height | Depth 46 | 48 cm

ohne Armteil  
without armrest

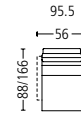

Relaxsessel elektrisch inkl. Akku + Herz-Waage . Relax Armchair electric incl. battery + heart balance  
Sitzhöhe | -tiefe . Seat Height | Depth 46 | 48 cm

ohne Armteil  
without armrest



Relaxsessel elektrisch inkl. Akku + Aufstehhilfe . Relax Armchair electric incl. battery + stand up assistance  
Sitzhöhe | -tiefe . Seat Height | Depth 46 | 48 cm

ohne Armteil  
without armrest



Armlehne . Armrest  
Breite . Width 7 cm

chrom glanz, offen  
chrome shiny, open



schwarz, offen  
black, open



Armlehne . Armrest  
Breite . Width 9 cm

bezogen  
covered

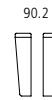

Armlehne . Armrest  
Breite . Width 7 cm

geschlossen  
closed



Fuss-Variation . Base variation

5-Sternfuss Alu poliert . 5-star base aluminium polished

V 994

5-Sternfuss Stahl schwarz . 5-star base steel black

V 996

5-Sternfuss Stahl Chrom glanz . 5-star base steel chrome glossy

V 993



castell









# castell 9131

Masse . Dimensions

Seitenansicht . Side View

Standard: Fuss Holz schwarz  
Standard: Foot wood black

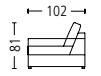

Plätze . Seats 2 | 2,5  
Sitzhöhe | -tiefe . Seat Height | Depth 40 | 56 cm

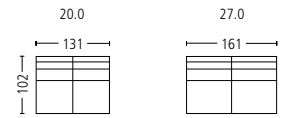

Plätze . Seats 3 | 3,5  
Sitzhöhe | -tiefe . Seat Height | Depth 40 | 56 cm

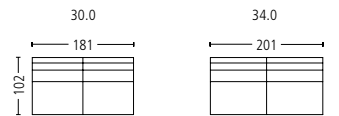

Eckelement . Cornerelement  
Sitzhöhe | -tiefe . Seat Height | Depth 40 | 56 cm

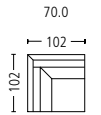

Liege kurz . Couch short  
Sitzhöhe | -tiefe . Seat Height | Depth 40 | 160 cm

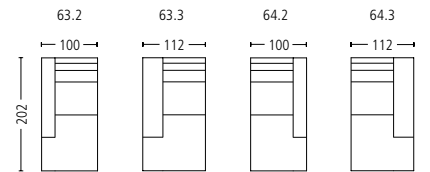

Hocker . Stool  
Sitzhöhe | -tiefe . Seat Height | Depth 40 | 71 cm

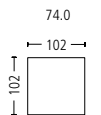

Armlehne . Armrest

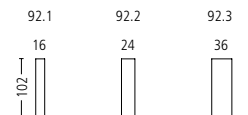

Kopfstütze . Headrest

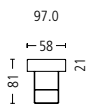

Fuss-Variation . Base variation

Fuss Holz alufarbig lackiert . Foot wood aluminium coloured lacquered  
Fuss Holz RAL . Foot wood RAL





# castell II



## castell II 9132

Masse . Dimensions

Seitenansicht . Side View	Standard: Fuss Alu poliert Standard: Foot aluminium polished	Fussstütze . Footrest Höhe   Tiefe . Height   Depth 43   43 cm			
Plätze . Seats	2   2,5	Sitzhöhe   -tiefe . Seat Height   Depth	45   56 cm		
Plätze . Seats	3   3,5	Sitzhöhe   -tiefe . Seat Height   Depth	45   56 cm		
Eckelement . Cornerelement	Sitzhöhe   -tiefe . Seat Height   Depth	45   56 cm			
Liege kurz . Couch short	Sitzhöhe   -tiefe . Seat Height   Depth	45   160 cm			



Hocker . Stool  
 Sitzhöhe | -tiefe . Seat Height | Depth 45 | 71 cm



Armlehne l/r . Armrest l/r



Kopfstütze . Headrest



Kombination . Combination  
 Sitzhöhe | -tiefe . Seat Height | Depth 45 | 56 cm



Kombination . Combination  
 Sitzhöhe | -tiefe . Seat Height | Depth 45 | 56 cm



Fuss-Variation . Base variation  
 Fuss Alu gebürstet matt . Foot aluminium brushed matt V 982  
 Fuss Alu schwarz . Foot aluminium black V 996







**pilatus 3286** Seitenteil bezogen . Side piece upholstered  
**pizol 3287** Seitenteil Chrom . Side piece chrome

Masse . Dimensions

Seitenansicht . Side View	Standard Relaxesessel: 5-Sternfuss Standard Relax Armchair: 5-star base	
Relaxesessel . Relax Armchair Sitzhöhe   -tiefe . Seat Height   Depth	47   51 cm	
Relaxesessel hoch . Relax Armchair high Sitzhöhe   -tiefe . Seat Height   Depth	47   51 cm	
Hocker . Stool Sitzhöhe . Seat Height	44 cm	Standard Hocker: 4-Sternfuss . Standard Stool: 4-star base
Kombination . Combination Relaxesessel mit Hocker Relax Armchair with stool Sitzhöhe   -tiefe . Seat Height   Depth	47   51 cm	
Bezug-Variation . Cover variation	Korpus Relaxesessel unten echt bezogen . Relax Armchair body with genuine upholstery underneath	V 885

malans



## malans 3252

Masse . Dimensions

Seitenansicht . Side View	Standard: Rundbogenfuss Standard: Round arched foot	Fussstütze **. Footrest ** Höhe Tiefe . Height Depth 43 44 cm			
Plätze . Seats Sitzhöhe -tiefe . Seat Height Depth	2 44 55 cm				
Plätze * . Seats * Sitzhöhe -tiefe . Seat Height Depth	2,5 44 55 cm				
Plätze * . Seats * Sitzhöhe -tiefe . Seat Height Depth	3 44 55 cm				



Liege l/r . Couch l/r  
Sitzhöhe | Liegetiefe  
Seat Height | Couch Depth

44 | 119 cm

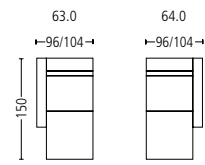

Eckelement . Cornerelement  
Sitzhöhe | -tiefe . Seat Height | Depth

44 | 55 cm

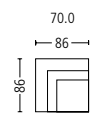

Hocker . Stool  
Sitzhöhe . Seat Height

42 cm



Nackensütze verstellbar  
Adjustable neck support

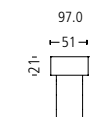

Kombination . Combination  
Sitzhöhe | -tiefe . Seat Height | Depth

44 | 55 cm

Block 6  
Elemente . Elements 27.5 | 64.0

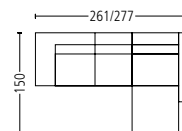

Block 75  
21.0 | 70.0 | 28.0

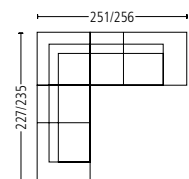

Fuss-Variation . Base variation

Fuss Alu 150 mm verstellbar . Feet aluminium 150 mm adjustable V 981

\*\* Fussstütze nur bei Sofas und Elementen mit \* | \*\* Foot rest only with sofas and elements with \*





xenia



xenia 9201

Masse . Dimensions

Seitenansicht . Side View

Standard: Fuss Alu poliert  
Standard: Foot aluminium polished



Sofa . Sofa  
Plätze . Seats 2,5 | 3  
Sitzhöhe | -tiefe . Seat Height | Depth 45 | 64 cm

Block 86  
Elemente . Elements 91.0 | 27.0 | 92.0

Block 104  
Elemente . Elements 91.0 | 30.0 | 92.0

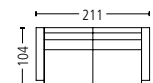
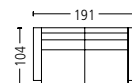

Plätze . Seats 2,5 | 3  
Sitzhöhe | -tiefe . Seat Height | Depth 45 | 64 cm

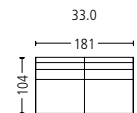
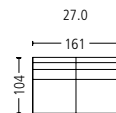

Segment . Segment 45 °  
 Sitzhöhe | -tiefe . Seat Height | Depth 45 | 57 cm

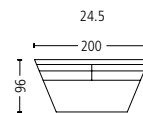

Liege l/r . Couch l/r  
 Sitzhöhe | Liegetiefe  
 Seat Height | Couch Depth 45 | 139 cm

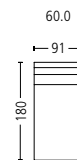

Armlehne l/r . Armrest l/r

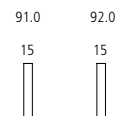

Kombination . Combination  
 Sitzhöhe | -tiefe . Seat Height | Depth 45 | 64 cm

Block 261  
 Elemente . Elements 91.0 | 30.0 | 60.0 | 92.0

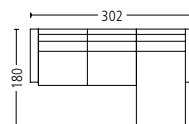

Block 238  
 Elemente . Elements 91.0 | 60.0 | 24.5 | 24.5 | 92.0

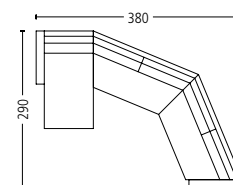

Fuss-Variation . Base variation

Fuss Alu schwarz . Foot aluminium black V 987



malix









Seitenansicht . Side View	Standard: Rundbogenfuss Standard: Round arched foot	Fussstütze **. Footrest ** Höhe Tiefe . Height Depth 43 44 cm	
---------------------------	--	--	--

Plätze . Seats	2	
Sitzhöhe -tiefe . Seat Height Depth	43 56 cm	

Plätze * . Seats *	2,5	
Sitzhöhe -tiefe . Seat Height Depth	43 56 cm	

Plätze * . Seats *	3	
Sitzhöhe -tiefe . Seat Height Depth	43 56 cm	

Element mit Abschlusshocker l/r Element with end stool l/r	2	
Plätze . Seats	2	
Sitzhöhe -tiefe . Seat Height Depth	43 56 cm	

Element mit Abschlusshocker l/r Element with end stool l/r	3	
Plätze . Seats	3	
Sitzhöhe -tiefe . Seat Height Depth	43 56 cm	

Liege l/r . Couch l/r		
Sitzhöhe Liegetiefe Seat Height Couch Depth	43 123 cm	

Eckelement . Cornerelement	43 56 cm	
----------------------------	----------	--

Hocker . Stool	41 cm	
Sitzhöhe . Seat Height	41 cm	

Nackenkissen . Neck Cushion		
-----------------------------	--	--

Kombination . Combination	43 56 cm	
Sitzhöhe -tiefe . Seat Height Depth	43 56 cm	

Fuss-Variation . Base variation Fuss Alu 150 mm verstellbar . Feet aluminium 150 mm adjustable V 981

\*\* Fussstütze nur bei Sofas und Elementen mit \* | \*\* Foot rest only with sofas and elements with \*





grimseL 3272

Masse . Dimensions

Seitenansicht . Side View

Standard: Fuss Alu verstellbar  
Standard: Foot aluminium adjustable



Sessel . Armchair

Sitzhöhe | -tiefe . Seat Height | Depth 43 | 52 cm

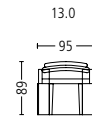

Plätze . Seats 2

Sitzhöhe | -tiefe . Seat Height | Depth 43 | 52 cm

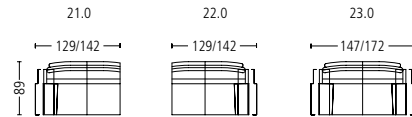

Plätze . Seats 2,5

Sitzhöhe | -tiefe . Seat Height | Depth 43 | 52 cm

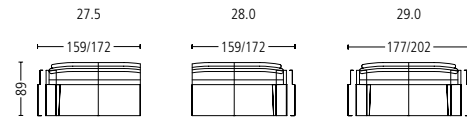

Plätze . Seats 3

Sitzhöhe | -tiefe . Seat Height | Depth 43 | 52 cm

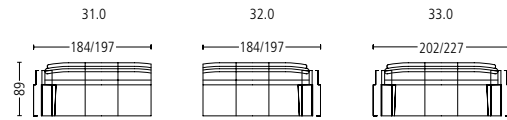

Sofa mit Abschlusshocker l/r

Sofa with end stool l/r

Plätze . Seats 3

Sitzhöhe | -tiefe . Seat Height | Depth 43 | 52 cm

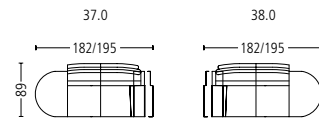

Element mit Abschlusshocker l/r

Element with end stool l/r

Plätze . Seats 2

Sitzhöhe | -tiefe . Seat Height | Depth 43 | 52 cm

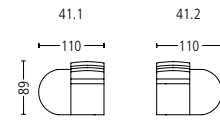

Element mit Abschlusshocker l/r

Element with end stool l/r

Plätze . Seats 3

Sitzhöhe | -tiefe . Seat Height | Depth 43 | 52 cm

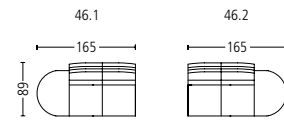

Liege l/r . Couch l/r

Sitzhöhe | Liegetiefe

Seat Height | Couch Depth 43 | 115 cm

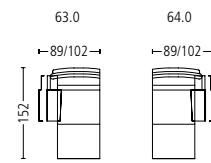

Eckelement . Cornerelement

Rundeckelement . Rounded Cornerelement

Sitzhöhe | -tiefe . Seat Height | Depth 43 | 52 cm

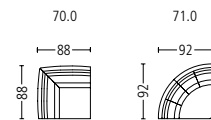

Hocker . Stool

Sitzhöhe . Seat Height 43 cm

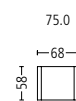

Nackenstütze verstellbar

Adjustable neck support

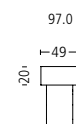

Fuss-Variation . Base variation

Fuss Alu schwarz verstellbar . Foot aluminium black adjustable V 991



Kombination . Combination  
 Sitzhöhe | -tiefe . Seat Height | Depth 43 | 52 cm

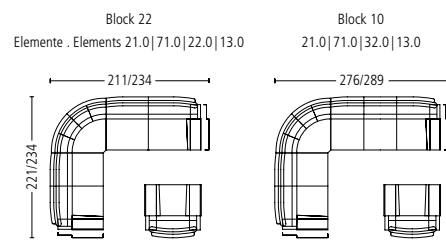

Kombination . Combination  
 Sitzhöhe | -tiefe . Seat Height | Depth 43 | 52 cm

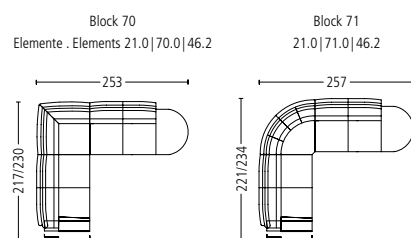

Kombination . Combination  
 Sitzhöhe | -tiefe . Seat Height | Depth 43 | 52 cm

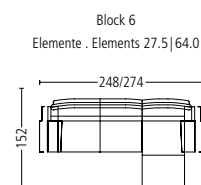



evita 3303

Masse . Dimensions

Seitenansicht . Side View	Standard: Knickfuss Chrom glanz Standard: Bent foot chrome glossy	Fussstütze **. Footrest ** Höhe   Tiefe . Height   Depth 43   43 cm	
Sessel . Armchair Sitzhöhe   -tiefe . Seat Height   Depth	44   54 cm		
Plätze . Seats Sitzhöhe   -tiefe . Seat Height   Depth	2 44   54 cm		
Plätze* . Seats* Sitzhöhe   -tiefe . Seat Height   Depth	2,5 44   54 cm		





Plätze\* . Seats\* 3  
 Sitzhöhe | -tiefe . Seat Height | Depth 44 | 54 cm

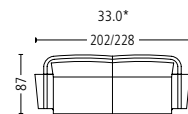

Hocker . Stool  
 Sitzhöhe . Seat Height 42 cm



Nackensstütze verstellbar  
 Adjustable neck support

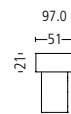

	Fuss Alu 150 mm verstellbar . Foot aluminium 150 mm adjustable	V 981
	Knickfuss chrom glanz + 2cm . Bent foot chrome glossy + 2cm	V 983
	Fuss Alu poliert . Foot aluminium polished	V 986
	Fuss Alu schwarz . Foot aluminium black	V 987
	Fuss Alu gebürstet matt . Foot aluminium brushed matt	V 990
	Knickfuss schwarz . Bent foot black	V 992
Fuss-Variation . Base variation	Knickfuss schwarz + 2cm . Bent foot black + 2cm	V 995

\*\* Fusstütze nur bei Sofas und Elementen mit \* | \*\* Foot rest only with sofas and elements with \*



elan 3302

Masse . Dimensions

Seitenansicht . Side View

Standard: Knickfuss Chrom glanz  
Standard: Bent foot chrome glossy



Fussstütze \*\*. Footrest \*\*

Höhe | Tiefe . Height | Depth

43 | 43 cm

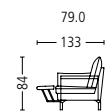

Plätze . Seats

Sitzhöhe | -tiefe . Seat Height | Depth

2

43 | 51 cm

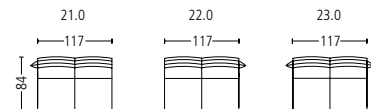

Plätze \* . Seats \*

Sitzhöhe | -tiefe . Seat Height | Depth

2,5

43 | 51 cm

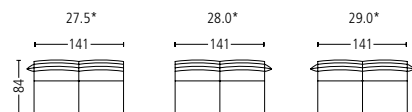

Plätze \* . Seats \*

Sitzhöhe | -tiefe . Seat Height | Depth

3

43 | 51 cm

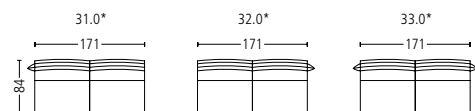

Zwischenelement * . Intermediate element *			10.0*
Plätze . Seats	1		71
Sitzhöhe -tiefe . Seat Height Depth	43 51 cm		
Anbauelement * . Extension element *			11.0* 12.0*
Plätze . Seats	1		71
Sitzhöhe -tiefe . Seat Height Depth	43 51 cm	für Armteil l/r   for armrest l/r	84
Anbauelement mit Abschlussocker * Extension element with end stool *			43.1* 43.2*
Plätze . Seats	1		112
Sitzhöhe -tiefe . Seat Height Depth	43 51 cm		84
Liege für Armlehne l/r Couch for armrest l/r			63.0 64.0
Sitzhöhe Liegetiefe Seat Height Couch Depth	43 116 cm		86
Eckelement . Cornerelement			70.0
Sitzhöhe -tiefe . Seat Height Depth	43 51 cm		87
Hocker . Stool			75.0
Sitzhöhe . Seat Height	40 cm		73
Armlehne schmal mit Kissen l/r Armrest narrow, with cushion l/r			91.3 92.3
			18 18
Nackenstütze verstellbar Adjustable neck support			97.0
			49
Kombination . Combination			Block 264
Sitzhöhe -tiefe . Seat Height Depth	45 56 cm		246
Kombination . Combination			Block 267
Sitzhöhe -tiefe . Seat Height Depth	45 56 cm		251
Fuss-Variation . Base variation		Fuss Alu 150 mm verstellbar . Foot aluminium 150 mm adjustable	V 981
		Fuss Alu gebürstet . Foot aluminium brushed	V 985
		Rundbogenfuss . Round arched foot	V 989

\*\* Fussstütze nur bei Elementen mit \* | \*\* Foot rest only with elements with \*





avegno



avegno 3263

Masse . Dimensions

Seitenansicht . Side View

Standard: Knickfuss Chrom glanz  
Standard: Bent foot chrome glossy



Fussstütze \*\*. Footrest \*\*  
Höhe | Tiefe . Height | Depth

43 | 44 cm

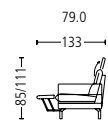

Sessel . Armchair

Sitzhöhe | -tiefe . Seat Height | Depth

44 | 56 cm

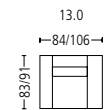

Plätze . Seats

2

Sitzhöhe | -tiefe . Seat Height | Depth

44 | 56 cm

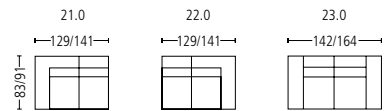

Plätze \* . Seats \*

2,5

Sitzhöhe | -tiefe . Seat Height | Depth

44 | 56 cm

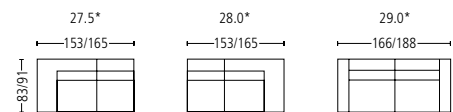

Plätze \* . Seats \*

3

Sitzhöhe | -tiefe . Seat Height | Depth

44 | 56 cm

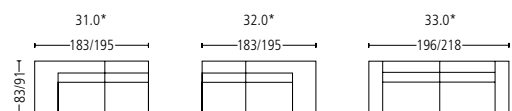

<b>Element mit Abschlusshocker</b> <b>Element with end stool</b> Plätze . Seats 2   3 Sitzhöhe   -tiefe . Seat Height   Depth 44   56 cm	
<b>Liege l/r . Couch l/r</b> Sitzhöhe   Liegetiefe Seat Height   Couch Depth 44   124 cm	
<b>Eckelement . Cornerelement</b> Sitzhöhe   Liegetiefe . Seat Height   Depth 44   56 cm	
<b>Hocker . Stool</b> Sitzhöhe . Seat Height 41 cm	
<b>Nackenkissen . Neck Cushion</b>	
<b>Kombination . Combination</b> Sitzhöhe   -tiefe . Seat Height   Depth 44   56 cm	
<b>Fuss-Variation . Base variation</b>	Fuss Alu 150mm verstellbar . Foot aluminium 150 mm adjustable V 981 Fuss Alu poliert . Foot aluminium polished V 986 Fuss Alu schwarz . Foot aluminium black V 987 Fuss Alu gebürstet matt . Foot aluminium brushed matt V 990

\*\* Fussstütze nur bei Sofas und Elementen mit \* | \*\* Foot rest only with sofas and elements with \*





praden 3267

Masse . Dimensions

Seitenansicht . Side View

Standard: Fuss Nussbaum . Standard: Foot walnut



Sessel . Armchair

Sitzhöhe | -tiefe . Seat Height | Depth 43 | 49 cm

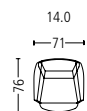

Fuss-Variationen . Base variations

Fuss Buche natur . Foot beech natural	V 981
Fuss Alu gebürstet matt . Foot aluminium brushed matt	V 982
Fuss Chrom glanz . Foot chrome shiny	V 983
Fuss Alu 150 mm verstellbar . Foot aluminium 150 mm adjustable	V 984
Fuss Alu gebürstet . Foot aluminium brushed	V 985
Fuss Alu poliert . Foot aluminium polished	V 986
Fuss Alu schwarz . Foot aluminium black	V 987





**sir** 3103

Masse . Dimensions

Seitenansicht . Side View

Standard: Alu-Zylinderfuss verstellbar . Aluminium cylindrical base adjustable



Sessel . Armchair  
Sitzhöhe | -tiefe . Seat Height | Depth      41 | 50 cm

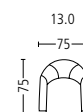

Fuss-Variation . Base variation

Rollen schwarz . Rolls black

V 982

amphora





amphora



# amphora 9198

Masse . Dimensions

Seitenansicht . Side View

Standard: 5-Sternfuss Stahl schwarz  
Standard: 5-star foot steel black



Relaxsessel elektrisch inkl. Akku . Relax Armchair electric incl. battery  
Sitzhöhe | -tiefe . Seat Height | Depth 48 | 51 cm

ohne Armteil  
without armrest

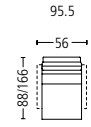

Relaxsessel elektrisch inkl. Akku + Herz-Waage . Relax Armchair electric incl. battery + heart balance  
Sitzhöhe | -tiefe . Seat Height | Depth 48 | 51 cm

ohne Armteil  
without armrest

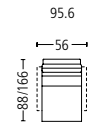

Relaxsessel elektrisch inkl. Akku + Aufstehhilfe . Relax Armchair electric incl. battery + stand up assistance  
Sitzhöhe | -tiefe . Seat Height | Depth 48 | 51 cm

ohne Armteil  
without armrest

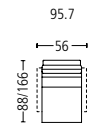

Armlehne . Armrest  
Breite . Width

8 cm

90.5  
schwarz  
black



90.1  
chrom glanz  
chrome shiny

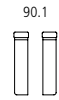

Fuss-Variation . Base variation

5-Sternfuss Stahl Chrom glanz . 5-star base steel chrome glossy

V 993



achilles cover



# achilles cover 9177 | Design Jan Armgardt

Masse . Dimensions

Seitenansicht . Side View

Standard: Fussplatte Chrom glanz . Base plate chrome glossy

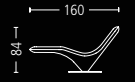

Loungechair . Loungechair  
Sitzhöhe | -tiefe . Seat Height | Depth 36 | 55 cm

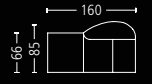

Kissen . Cushion

	95.5	98.0
Zierkissen Decorative Cushion		
		Nackenkissen Neck Cushion

Fuss-Variation . Base variation

Fussplatte Chrom gebürstet . Base plate chrome brushed V 983

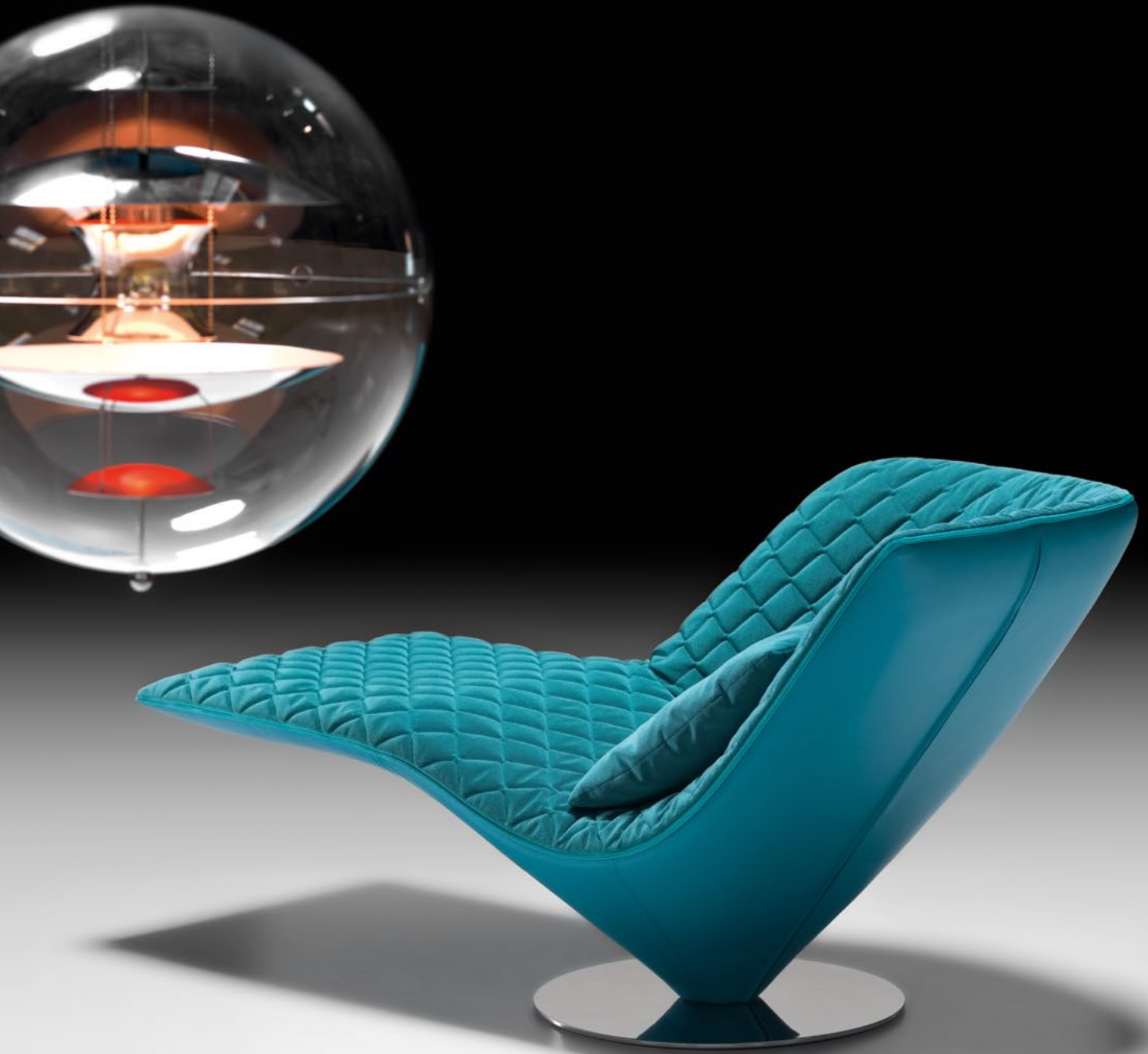









## spiez 3308

Masse . Dimensions

Seitenansicht . Side View

Standard: Fuss Alu poliert  
Standard: Foot aluminium polished



Fussstütze \*\*. Footrest \*\*

Höhe | Tiefe . Height | Depth 43 | 44 cm

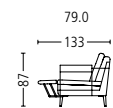

Plätze . Seats

Sitzhöhe | -tiefe . Seat Height | Depth 45 | 52 cm

2

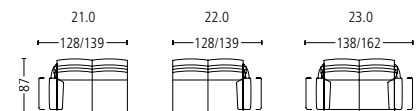

Plätze \* . Seats \*

Sitzhöhe | -tiefe . Seat Height | Depth 45 | 52 cm

2,5

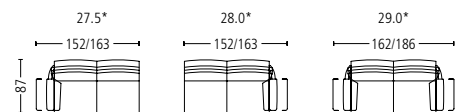

Plätze \* . Seats \*

Sitzhöhe | -tiefe . Seat Height | Depth 45 | 52 cm

3

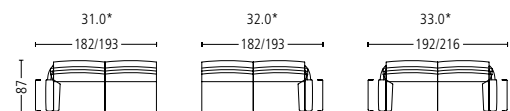



Liege l/r . Couch l/r  
Sitzhöhe | Liegetiefe  
Seat Height | Couch Depth

45 | 115 cm

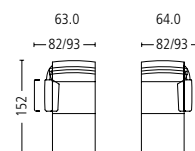

Eckelement . Cornerelement  
Sitzhöhe | -tiefe . Seat Height | Depth

45 | 52 cm



Hocker . Stool  
Sitzhöhe . Seat Height

45 cm



Nackensstütze verstellbar  
Adjustable neck support

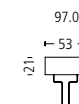

Kombination . Combination  
Sitzhöhe | -tiefe . Seat Height | Depth

45 | 52 cm

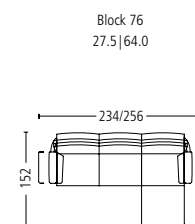
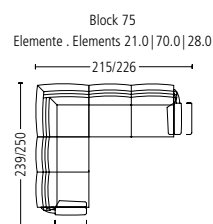

Fuss-Variation . Base variation

Fuss Alu schwarz . Foot aluminium black

V 987

Fuss Alu gebürstet matt . Foot aluminium brushed matt

V 982

\*\* Füssstütze nur bei Sofas und Elementen mit \* | \*\* Foot rest only with sofas and elements with \*

melide







melide 3273

Masse . Dimensions

Seitenansicht . Side View	Standard: Knickfuss Chrom glanz Standard: Bent foot chrome glossy	Fussstütze **. Footrest ** Höhe   Tiefe . Height   Depth 42   44 cm	
Sessel . Armchair	Sitzhöhe   -tiefe . Seat Height   Depth 43   52 cm		
Sofa . Sofa	Plätze . Seats 2   2,5 Sitzhöhe   -tiefe . Seat Height   Depth 43   52 cm		
Element . Element	Plätze . Seats 1   1,5   2   2,5 Sitzhöhe   -tiefe . Seat Height   Depth 43   52 cm		
Element mit Abschlusshocker l/r Element with end stool l/r	Plätze . Seats 2 Sitzhöhe   -tiefe . Seat Height   Depth 43   52 cm		
Element mit Abschlusshocker l/r Element with end stool l/r	Plätze . Seats 3 Sitzhöhe   -tiefe . Seat Height   Depth 43   52 cm		
Liege l/r . Couch l/r	Sitzhöhe   Liegetiefe Seat Height   Couch Depth 43   116 cm		



Eckelement . Cornerelement  
Sitzhöhe | -tiefe . Seat Height | Depth 43 | 52 cm

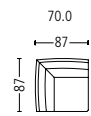

Hocker . Stool  
Sitzhöhe . Seat Height 41 cm

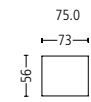

Armlehne l/r . Armrest l/r

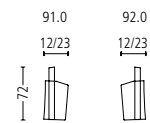

Kombination . Combination  
Sitzhöhe | -tiefe . Seat Height | Depth 43 | 52 cm

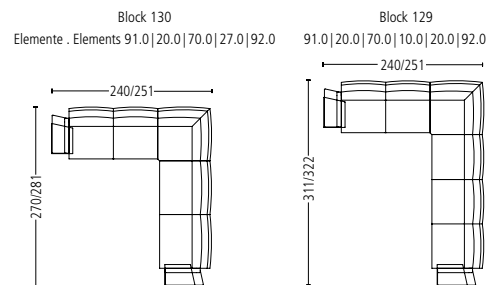

Nackenstütze verstellbar  
Adjustable neck support

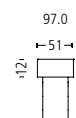



Fuss-Variation . Base variation

Fuss Alu 150 mm verstellbar . Foot aluminium 150 mm adjustable	V 981
Knickfuss Chrom glanz + 2cm . Bent foot chrome glossy + 2cm	V 983
Knickfuss schwarz . Bent foot black	V 992
Knickfuss schwarz + 2cm . Bent foot black + 2cm	V 995

leo



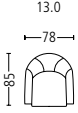
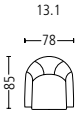

Seitenansicht . Side View	Standard: 5-Sternfuss Alu schwarz Standard: 5-star base aluminium black		mit Wipp-Funktion with rocking function	
Sessel . Armchair	Sitzhöhe   -tiefe . Seat Height   Depth	45   55 cm		
Sessel mit Wipp-Funktion . Armchair with rocking function	Sitzhöhe   -tiefe . Seat Height   Depth	45   55 cm		
Variationen . Variations	5-Sternfuss Alu poliert . 5-star base aluminium polished			V 1
	Sitzhöhe 49 cm . Seat Height 49 cm			V 2

Mit manueller Wipp-Funktion noch vielseitiger: schwungvoller Einsatz im Arbeitszimmer oder pure Entspannung im Wohnbereich, dieser Charakterkopf macht immer und überall eine gute Figur.

Even more versatile with manual rocking function: lively use in the study or pure relaxation in the living area, this character head cuts a fine figure anywhere and at any time.





delphi 9095 | Design Michael C. Brandis

Masse . Dimensions

Seitenansicht . Side View

Standard: Fuss Alu verstellbar  
Standard: Foot aluminium adjustable



Plätze . Seats 2 | 2,5  
Sitzhöhe | -tiefe . Seat Height | Depth 43 | 54 cm

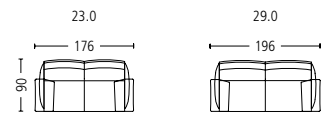

Segmente . Segments 60°  
Sitzhöhe | -tiefe . Seat Height | Depth 43 | 54 cm

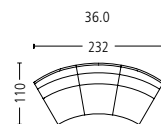



Liege l/r . Couch l/r  
 Sitzhöhe | -tiefe . Seat Height | Depth 43 | 118 cm

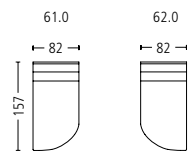

Kombination . Combination  
 Sitzhöhe | -tiefe . Seat Height | Depth 43 | 54 cm

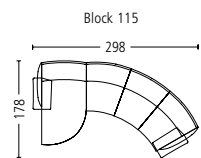

Kopfstütze . Headrest

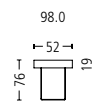

Fuss-Variation . Base variation

Fuss Buche gebeizt: Lack RAL-Farben . Foot stained beech: lacquer RAL colours V 981  
 Fuss Aluminium hochglanz . Foot aluminium high glossy V 984





Seitenansicht . Side View

Standard: Fuss Alu gebürstet  
Standard: Foot aluminium brushed



Fussstütze \*\* . Footrest \*\*

Höhe | Tiefe . Height | Depth

43 | 44 cm

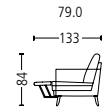

Plätze . Seats

2

Sitzhöhe | -tiefe . Seat Height | Depth

43 | 51 cm

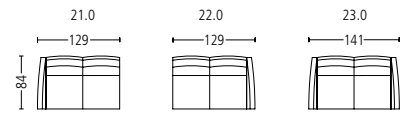

Plätze \* . Seats \*

2,5

Sitzhöhe | -tiefe . Seat Height | Depth

43 | 51 cm

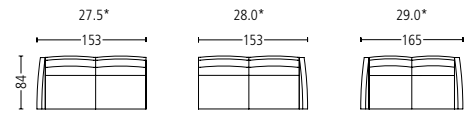

Plätze \* . Seats \*

3

Sitzhöhe | -tiefe . Seat Height | Depth

43 | 51 cm

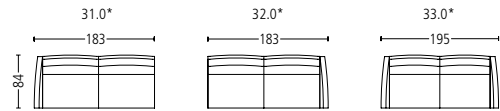

Liege mit Armlehne l/r

Couch with armrest l/r

Sitzhöhe | Liegetiefe

Seat Height | Couch Depth

43 | 116 cm

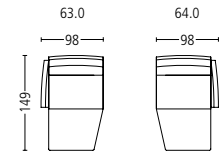

Nackenstütze verstellbar

Adjustable neck support

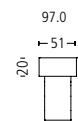

Kombination . Combination

Sitzhöhe | -tiefe . Seat Height | Depth

42 | 51 cm

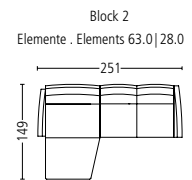

Fuss-Variation . Base variation

Fuss Alu 150 mm verstellbar . Foot aluminium 150 mm adjustable V 981

Knickfuss Chrom glanz . Bent foot chrome glossy V 983

\*\* Fussstütze nur bei Sofas und Elementen mit \* | \*\* Foot rest only with sofas and elements with \*



Die hier in der Broschüre abgebildeten Produkte und Grundrisszeichnungen sind als Orientierungshilfe zu verstehen. Alle Masse sind Zirka-Angaben. Sind zwei Masse angegeben, so ist das zweite Mass inklusive der losen Seitenteilkissen oder der abgelegten Funktionsteile zu verstehen. Änderungen im Sinne des Fortschritts sind vorbehalten.

The illustrated products and diagrams in the brochure are an orientation aid. All measurements are approximate calculations and relate to the entire measurement including the cushion overlap. If two dimensions are given, then the second dimension includes the loose side cushions or the stored functional components. In relation to progress, they are subject to adjustments.



Tradition trifft auf Innovation. International erfolgreiches Design trifft auf Schweizer Handwerkskunst. Das macht uns seit über neun Jahrzehnten erfolgreich. Mehr zu unserer Geschichte finden Sie auch unter [www.artanova-horst.ch](http://www.artanova-horst.ch).

Tradition meets innovation. Internationally successful Design meets Swiss craftsmanship. This has made us successful more than 9 decades. More about our history – see [www.artanova-horst.ch](http://www.artanova-horst.ch).

---

#### **Horst AG**

Bahnhofstrasse 25 | CH-6422 Steinen | Schwyz  
Tel. +41 (0)41 833 83 83 | Fax +41 (0)41 833 83 30  
[info@artanova-horst.ch](mailto:info@artanova-horst.ch) | [www.artanova-horst.ch](http://www.artanova-horst.ch)

**artanova** **horst**  
Switzerland Collection